



MESSITEENUSED
2019
FAIR SERVICES

Tere tulemast Eesti Näituste messikeskusesse, Eesti suurimasse messikeskusesse!



Hoiad käes Eesti suurima messikeskuse tellimispaketti. Siit leiad kõik vajaliku messide ja näituste tarbeks. Meie teenuste laik valik loob Teile kõik võimalused, et messidel osalemine oleks õnnestunud ja tulemusrikas. Tulemusrikas messidel ja näitustel osalemine eeldab hoolsat eelplaneerimist ja mitmete erialaspetsialistide laitmatut koostööd. Meilt saad asjatundlikku ja kvaliteetset teenust alates standi kujundusest kuni teostuseni. Meie spetsialistide ja koostööpartnerite abil

saad korrigeerida kogu messitegevust. Nii võid olla kindel, et õige teave jõuab kohale, õiged kontaktid kohtuvad ja et see viib ka reaalsete tulemusteni.

Käesolevast paketist leiad kõik meie pakutavad teenused.

Vajadused on alati individuaalsed, koos saavutame parima tulemuse.

Võta meiega ühendust ning muudame koos messil osalemise kordaläinuks!

We welcome you to the Estonian Fairs Centre, Estonian biggest fair centre!



You are holding the service guide of Estonian biggest fair organizer. In this guide you'll find everything you need to get the best out of the fair media, exhibitions and events. Our wide range of services helps you ensure that your presence in the facilities of the Estonian Fairs Centre is successful and productive.

Successful participation in fairs and events calls for careful planning and seamless cooperation from professionals in many different fields. We can help you with expert services from professionals in designing and

setting up stands. With the help of our professionals and experienced partners you'll be able to control the entire fair and event process. In this way you'll be able to ensure that correct information is communicated, that the right contacts are made – and that the contacts lead to results.

Our brochure introduces our extensive range of services.

Each exhibitor has different needs: the best result is achieved by planning together.

Get in touch with us: let's join forces to turn your participation into a success story!

Sisukord / Contents

Stendi kujundamine / Stand design	4
Erikujuline stand / Design stand	5
Standardstend / Standard stand	6
Profiilide ja kilpide mõõdud/Dimensions of profiles and panels	7
Konstruksioonielemendid / Constructions	8
Mööbel / Furniture	9
Vaipkatted / Carpets	13
Kodumasinad / Household appliances	14
Santehnika ja suruõhuhendus / Kitchen and compressed air techniques	14
Valgustus ja elekter/ Lighting and electrics	15
Jäätmekäitlusvahendid / Waste handling appliances	16
Koristusteenus / Cleaning services	16
AV-teenused ja –tehnika / AV-services and technics	17
Tõste- ja riputusteenused / Lifting and hanging services	18
Muud teenused / Other services	18
Hüvitised / Amendments	18
Graafikateenused / Graphics services	19
Otsalaualogod ja –tekstid / Fascia logos and texts	20
Kunstlilled ja-puud / Decorative plants	20
Internetiühendus / Internet connections	20
Logistikateenused / Logistics services	21
Toitlustusteenused / Catering services	21
Konverentsiteenused / Conference services	22
Kontserdi-, peo- ja esitlusteenused	22
Renditingimused / Rental terms	24
Maksetingimused / Terms of payment	24
Stendi joonis / Stand sketch	25
Eesti Näituste messikeskus / Estonian Fairs Centre	26
Messikeskuse asukoht ja üldkontaktid / How do get there and general contacts	28
Eksponeendi memo / Exhibitors memo	29

Stendi kujundamine Stand design



4

Messiks ettevalmistamisega tasub alustada varakult. Stendi kujundamisel on suur tähtsus, on ju messistend ettevõtte visiitkaart.

Messil osalemise eesmärgid, eksponaatide hulk ja tegevus messistendil määravad ka stendi suuruse ja varustatuse. Loomulikult oluline ka eelarve. Seepärast pakume erinevaid lahendusi.

Pakume palju võimalusi messistendi ehitamiseks.

Valikus on järgmised variandid:

- standardstend on mugavaim võimalus baasstendi tellimiseks juba messile registreerumisel.
- üksikud tooted, millest ehitatakse terve stend või mida saab täiendavalt standardstendile lisada
- erikujuline stend, meie disaineriga koostöös kujundatud erikujuline, ettevõtte imago väljendav stend
- kliendi enda olemasolevate jooniste järgi ehitatud stend

Abistame kõigis stendi kujundamise ja ehitamisega seonduvates küsimustes. Võtke ühendust ja küsige pakkumist.

Planning your participation in a fair takes time. For a few days your stand is the face to the outside world.

Your goals, quantity of exhibits and the activity on the stand put certain demands on the size and the furnishing. Also the budget has its influence. Therefore we offer you a wide range of alternatives.

We offer you different alternatives.

Please choose a suitable option:

- standard stand is easiest way to order basic stand already when you register for a fair.
- single products of which you can build a whole stand or complete your stand
- design stand, a tailor-made stand designed by one of our designers
- a stand based on your own drawings

We assist you in all matters related to stand building. Please do not hesitate to ask for an offer!

Erikujuline stand Design stand

Muudame Teie ideed hästi töötavaks messistendiks!



5

Õnnestunud messistend kujundatakse alati messil osalemise eesmärkidest lähtuvalt. Ettevõtte imago väljendav stand toetab kõige paremini eesmärkide saavutamist. Ehitame Teie messistendi oskuslikult ja organiseerime Teie eest ka kõik sellega kaasneva.

Eesti Näituste disaineritel on rahvusvaheline kogemus väga erinevate erialade erikujuliste standide kujundamisel. Neilt saad erinevaid ideelahendusi.

Võta meiega ühendust ja loome koos stendi millega saavutate soovitud eesmärgi.

The design of a successful fair stand always starts from the goals set for participation at the fair. A stand that reflects your corporate image supports the achievement of your goals best. We'll apply our professional skill in designing and building your stand and take care of all the practical matters for you.

The designers at Estonian Fairs are in a unique position to follow international trends in various fields. They will also be able to offer you the latest ideas for new solutions that will give your ideas concrete shape.

Get in touch with us, and we'll join forces to create a framework for achieving your goals.

Standardstend

Standard stand

Eesti Näituste AS-i poolt korraldavatel messidel tellitakse standardstend messile registreerumisel. Standardstend sisaldab üldjuhul: ümbritsevad seinaelemendid, otsalaud, vaipkate, üldvalgustus ja pistikupesa.

Standardstendi saab täiendada erineva mööbli ja kujunduselementidega.

Eesti Näituste AS-i poolt mittekorraldatavate messide puhul palume kindlasti täpsustada korraldajalt milliseid elemente standardstend sisaldab.

In exhibitions arranged by Estonian Fairs Ltd, standard stands should be ordered in connection with registration. The stand usually includes walls, fascia, carpet, basic lighting and socket.

A standard stand can be supplemented with different furniture and decorations.

In exhibitions arranged by another organizer than Estonian Fairs Ltd, exhibitors should check with the organizer what constructions are included to the standard stand rental.

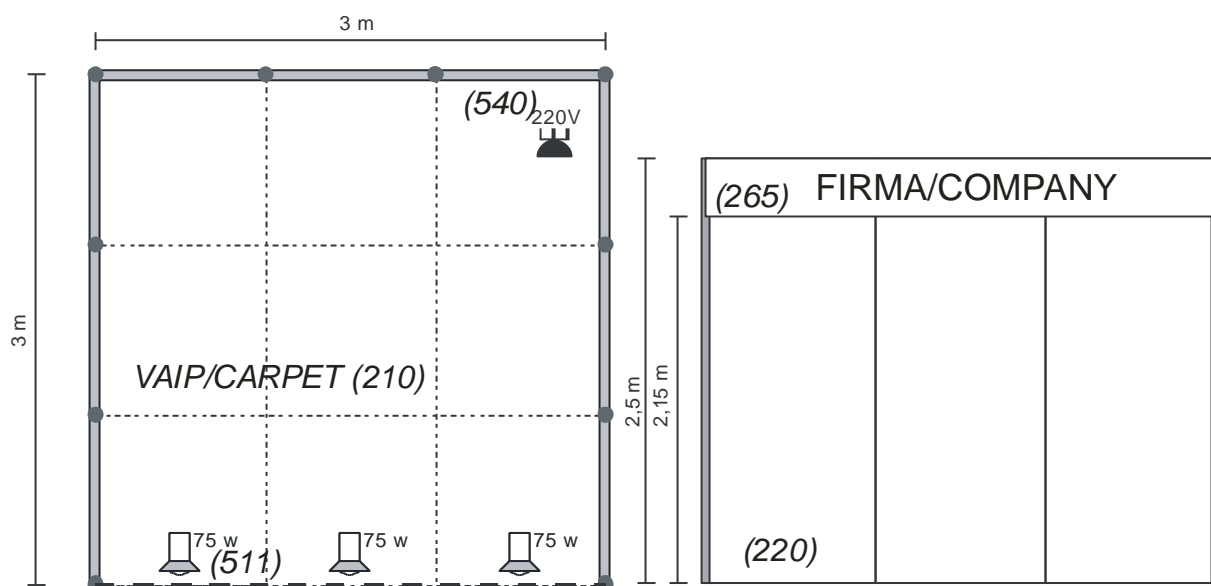

Konstruksioonid / Constructions

220	Seinaelemendid Wall elements	standardised alumiiniumprofili konstruktsiooniga valged seinad standard aluminium profiles and white walls
265	Otsalaud Fascia board	Puitkilp rippuv või profiilidevaheline valge Wooden hanging or profiles white panel
210	Vaipkate Carpet	rullvaip – helehall, tumehall, punane, sinine, helesinine või roheline rolling carpet – dark grey, red, blue or green

Elekter / Electrics

511	Valge kohtvalgusti lattjuhtmel White spotlight on wired profile
540	Pistikupesa kaitsekontaktiga 220V 1,0kW 4,5A (sisaldab elektri tarbimist) Plug socket 220V, 1,0kW 4,5A (includes consumption)

Profilide ja kilpide mõõdud

Dimensions of profiles and panels

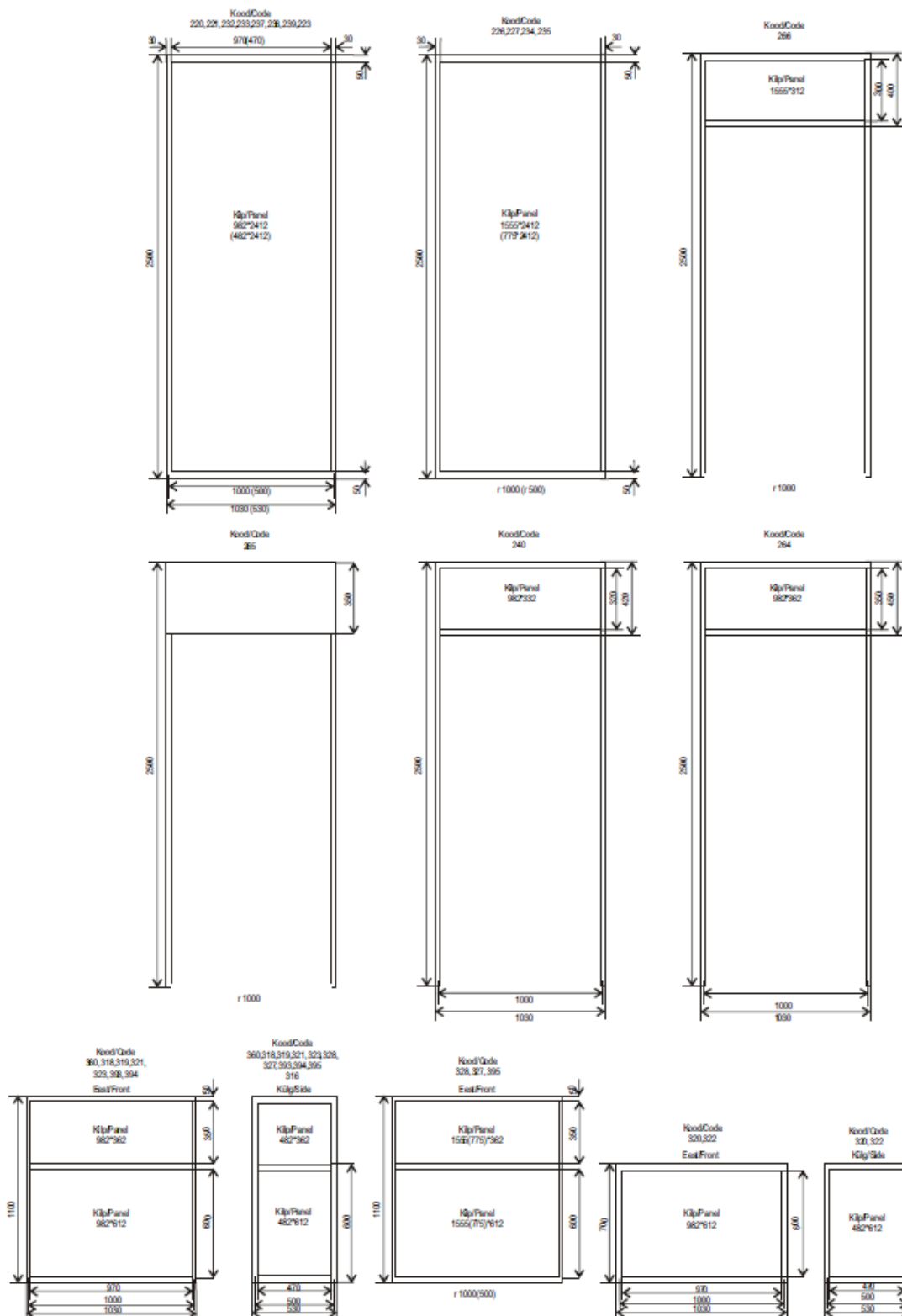

Konstruksioonelemendid / Constructions

Meie Consta Systems® profiilisüsteemil on palju erinevaid laiuse, kõrguse ja vormiga variante. Põhimaterjaliks on alumiiniumprofiilist karkass ja valge seinakilp.

Saadaval on samuti PVC ja BIP akrüülmaterjalist plaadid. Stendi isikupärasemaks muutmiseks on võimalik seinad katta sobivat tooni kilega. Profiili konstruktsioonidele on võimalik kinnitada reklaammaterjale ja bännereid tavalise kileteibiga (pärasst messi lõppu kindlasti eemaldada) ja riputuskonksudega.

Our Consta Systems® profile systems come in several widths, heights and shapes. The basic material is an aluminum-profile frame and white board.

PVC boards and BIP acrylic board can also be ordered. To make your stand more personal is possible to cover wall panels with color adhesives. Items can be attached to profile structures using adhesives (must be removed afterwards) or hooks.

8

Kood Code	Nimetus / Item	Hind € Price €
220	Seinaelement 100*h250cm valge/valge / Wall element 100*h250cm white/white	24,00
221	Seinaelement 50*h250cm valge/valge / Wall element 50*h250cm white/white	20,00
226	Kaarseinaelement r100*h250cm valge/valge / Curved wall element r100*h250cm white/white	55,00
227	Kaarseinaelement r50*h250cm valge/valge / Curved wall element r50*250cm white/white	45,00
232	Seinaelement 100*h250cm akrüül / Wall element 100*250cm acrylic	85,00
233	Seinaelement 50*h250cm akrüül / Wall element 50*250cm acrylic	65,00
234	Kaarseinaelement r100*h250cm akrüül / Curved wall element r100*h250cm acrylic	135,00
235	Kaarseinaelement r50*h250cm akrüül / Curved wall element r50*250cm acrylic	90,00
247	Peegelseinaelement 100*h170cm / Mirror wall element 100*h170cm	69,00
237	Peegelseinaelement 100*h250cm / Mirror wall element 100*h250cm	95,00
238	Peegelseinaelement 50*h=250 cm / Mirror wall element 50*h250cm	45,00
239	Seinaelement PVC 100*h250cm (punane, sinine, kollane, roheline, must) /PVC wall element 100*h250cm (red, blue, yellow, green, black)	45,00
223	Seinaelement BIP 100*h250cm (punane, sinine, kollane, roheline, must) / BIP wall element 100*h250cm (red, blue, yellow, green, black)	35,00
240	Tahvelukselement 100*h250cm lukustatav / Hinged door element 100*h250cm, lockable	38,00
260	Lükandukselement 100*h250cm lukustatav / Folding door element 100*h250cm, lockable	45,00
264	Kardinaelement 100*h250cm / Curtain element 100*h250cm	35,00
252	Laekarkass 1m ² / Frame for ceiling grid 1m ²	11,00
253	Laerest koos karkassiga 97*97cm / Ceiling grid with frame 97*97cm	21,00
254	Laerest koos karkassiga 47*97cm / Ceiling grid with frame 47*97cm	15,00
265	Otsalaud jm. / Fascia board hanging 1m	11,00
266	Kaarotsalaud jm. / Curved fascia board 1m	16,00
270	Panipaik uksega (m ²) (hinnas: seinaelemendid, uks) / Storage room with door (m ²)	50,00
271	Proovikabiin (m ²) (hinnas: seinaelemendid, kardin, peegel, seinanagi, kohtvalgusti 75W) / Fitting room (m ²) (includes curtain, mirror, wall hanger, spotlight 75W)	80,00

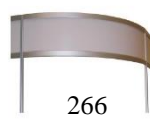

Mööbel / Furniture

Valikus on palju erinevat mööblit igale maitsele. Rendime mööblit ja konstruktsioone ka väljapool messikeskust toimuvatele üritustele.

Our range includes plenty of furniture. We also rent furniture and other exhibition structures for use in events outside Estonian Fairs Centre.



300/1



300/2*



303



306/1



306/2*



306/3

* Inventari on piiratud koguses/ limited amount of inventory

Kood Code	Nimetus / Item	Hind € Price €
Toolid/Chairs		
300	Tool / Chair	5,00
303	Konverentsitool / Conference chair	12,00
306	Baaritool / Bar chair	18,00



310



311



313*



315*

* Inventari on piiratud koguses/ limited amount of inventory

Kood Code	Nimetus / Item	Hind € Price €
Lauad/Tables		
310	Laud / Table 70*70 cm	15,00
311	Laud / Table 70*120 cm	20,00
312	Laud / Table 70*180 cm	25,00
313	Laud / Table Ø70 cm	18,00
314	Laud / Table Ø100 cm	22,00
315	Baarilaud / Bar table Ø60 h110 cm	18,00
360	Arvutilaud / PC table 53*103*70 cm	35,00

Hindadele lisatakse käibemaks 20%. VAT 20% will be added to the prices.



* Inventari on piiratud koguses/ limited amount of inventory

Kood Code	Nimetus / Item	Hind € Price €
Infoletid, kapid ja vitriinid/Info counters, cupboards and showcases		
317	Videoalus/ Video stand 53*53* h110 cm	24,00
316	Infolett usteta / Info counter without doors 53*53 h110 cm	30,00
318	Infolett usteta / Info counter without doors 53*103 h110 cm	35,00
319	Infolett ustega / Info counter with doors 53*103 h110 cm	41,00
328	Kaarinfolaud / Curved info counter without doors r50*h110 cm	43,00
327	Kaarinfolaud / Curved info counter without doors r100*h110 cm	53,00
320	Kapp / Cupboard 53*103 h70 cm	35,00
321	Kapp / Cupboard 53*103 h110 cm	37,00
322	Kapp, lukustatav / Cupboard, lockable 53*103 h70 cm	39,00
323	Kapp, lukustatav / Cupboard lockable 53*103 h110 cm	43,00
392	Vitriin usteta / Showcase without doors 53*53 h110 cm	38,00
393	Vitriin usteta / Showcase without doors 53*103 h110 cm	55,00
394	Vitriin ustega / Showcase with doors 53*103 h110 cm	67,00
395	Kaarvitriin usteta / Curved showcase without doors r100 h110 cm	88,00
397	Vitriin valgustamata / Showcase 53*53 h250 cm	65,00
398	Vitriin valgustamata / Showcase 53*103 h250 cm	80,00
399	Vitriin valgustatud / Showcase lightened 53*103 h250 cm	98,00

Hindadele lisatakse käibemaks 20%. VAT 20% will be added to the prices.

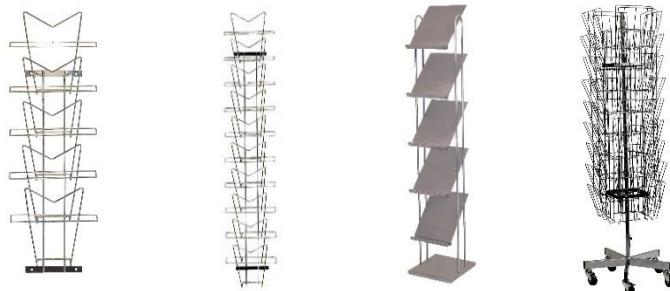

324

325

326*

329

* Inventari on piiratud koguses/ limited amount of inventory

Kood Code	Nimetus / Item	Hind € Price €
Ajakirjaalused/Literature holders		
324	Ajakirjaalus seinale / Literature holder, wall model 5*A4	7,00
325	Ajakirjaalus seinale / Literature holder, wall model 9*A4	11,00
326	Ajakirjaalus jalal / Literature holder, standing 5*A4	25,00
329	Ajakirjaalus ratastel / Literature holder wheeled 40*A4	27,00



340



342



380



381

Kood Code	Nimetus / Item	Hind € Price €
Lao- ja seinariulid/Storage and wall shelves		
340	Laoriul LUNDIA - puit 4-riuliga / 4 shelf storage unit LUNDIA 30*83 h208cm	27,00
342	Laoriul - valge 5-riuliga/ 5 shelf storage unit 40*93 h180 cm	32,00
380	Seinariul / Shelf, wall model 30*100 cm	15,00
381	Seinariul (kald) / Shelf, wall model (tilt) 30*100 cm	16,00

Kood Code	Nimetus / Item	Hind € Price €
Profiilid/Profiles		
281	Püstak / Square profile 110 cm	5,50
283	Püstak / Square profile 250 cm	11,00
284	Põõn / Beam profile 27 cm	4,00
285	Põõn / Beam profile 47 cm	5,00
286	Põõn / Beam profile 97 cm	7,00
287	Põõn / Beam profile 197 cm	9,00
288	Põõn / Beam profile 297 cm	12,00
289	Kaarpõõn / Curved profile R515	13,00
290	Kaarpõõn / Curved profile R1015	15,00
291	Syma-Molto 90 profiil/ profile m	19,00
292	Syma-Molto 90 nurgakuubik/ corner cube	11,00

Hindadele lisatakse käibemaks 20%. VAT 20% will be added to the prices.

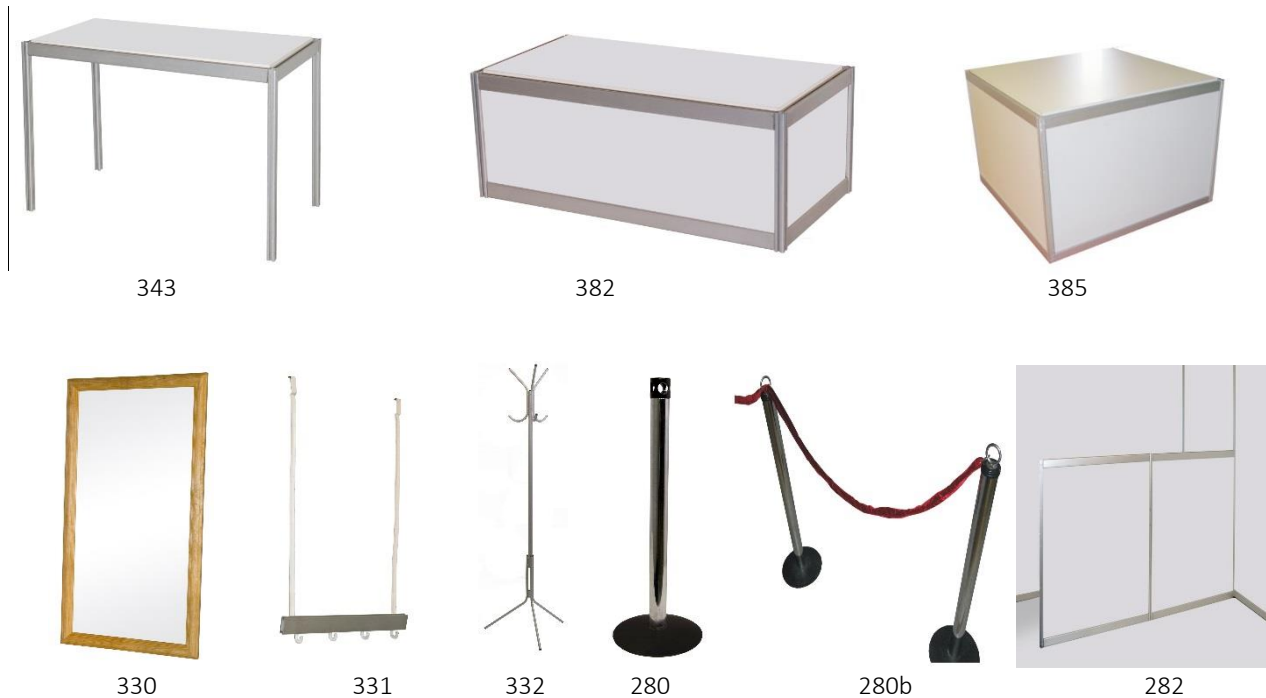

Kood Code	Nimetus / Item	Hind € Price €
Töötasapinnad ja poodiumid/Tables for exhibits and podiums		
343a	Töötasapind / Table for exhibits 53*103 h70 cm	23,00
343b	Töötasapind / Table for exhibits 53*103 h90 cm	23,00
343c	Töötasapind / Table for exhibits 53*103 h110 cm	23,00
344a	Töötasapind / Table for exhibits 103*103 h70 cm	27,00
344b	Töötasapind / Table for exhibits 103*103 h90 cm	27,00
344c	Töötasapind / Table for exhibits 103*103 h110 cm	27,00
382	Poodium / Podium 53*103 h40 cm	31,00
383	Poodium / Podium 53*103 h70 cm	33,00
384	Poodium / Podium 53*103 h110 cm	35,00
385	Poodium / Podium 103*103 h40 cm	33,00
386	Poodium / Podium 103*103 h70 cm	35,00
387	Poodium / Podium 103*103 h110 cm	37,00
Muu mööbel/Other furniture		
330	Peegel / Mirror 40*h100 cm	7,00
333	Meigi/peeglilaud 53*103 h200cm (lauaosa h70cm)/ Make-up/dressing table 53*103 h200cm (table h70cm)	36,00
331	Seinanagi / Clothes rack, wall model	6,00
332	Pörandanagi / Clothes rack standing	13,00
280	Piirdepost / Boundary pole	11,00
280a	Köis piirdepostidele 2,5m (tavaline) / Rope for poles 2,5m (regular)	5,00
280b	Köis piirdepostidele 2,5m (punane samet) / Rope for poles 2,5m (red velvet)	8,00
282	Piire / Front partition element 100*h105 cm	17,00

Vaipkatted / Carpets

Meie valikus on mitmeid eri värve plaat- ja rullvaipu. Hind sisaldab paigaldamist, renti ja eemaldamist ning kile eemaldamist enne messi algust.

Our range includes several types of carpet tiles and carpet rolls. Prices include installation, rent and removal as well as removal of plastic cover before fairs starts.

Eesti Näituste messikeskuses renditavate põrandakatete värvitoonid RENTED CARPETS TONES

VAIP 916 CARPET

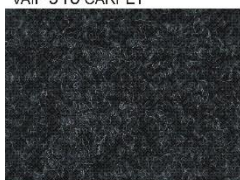

VAIP 708 CARPET



VAIP 502 CARPET



VAIP 506 CARPET



VAIP 402 CARPET



VAIP 105 CARPET



Plaatvaipade värvitoonid

Carpet tiles tones

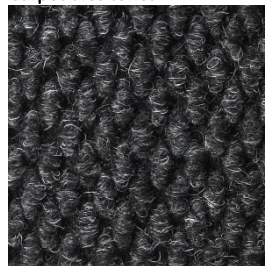

Tumehall/Dark grey



Helehall/Light grey



Punane/Red

- Teised värvitoonid on saadaval on eritellimusel ning -hinnaga.
- Other tones are available with special order and-price.

Kood Code	Nimetus / Item	Hind € Price €
210	Rullvaip(hall, tumehall, punane, tumesinine, helesinine, roheline) koos paigaldusega/ Carpet roll (grey, black, red, light blue, dark blue, green) with installation 1m ²	6,00
211	Vaibakile koos paigaldusega / Plastic for carpet with intallation 1m ²	1,00
212	Plaatvaip (50*50 cm) (helehall, tumehall, punane) koos paigaldusega / Carpet tiles (0,5*0,5) (light grey, dark grey, red) with installation 1m ²	7,00

Kodumasinad / Household appliances



350



370



370



371*

* Inventari on piiratud koguses/ limited amount of inventory

Kood Code	Nimetus / Item	Hind € Price €
350	Külmutuskapp/ Refrigerator	45,00
370	Kohviaparaat (maht 10 tassi) / Coffee percolator (10 cups)	14,00
371	Täisautomaatne espressomasin (period)/ Espresso maker (period)	99,00

NB! Elektriühendused kohvimasinatele (370 ja 371) ja külmutuskapile (350) on vaja tellida eraldi.
Electrical installations for coffee makers (370 and 371) and refrigerators (350) should be ordered separately.

Santehnika ja suruõhuühendus / Kitchen and compressed air techniques



600



601/603

Kood Code	Nimetus / Item	Hind € Price €
600	Kombineeritud köök (külmik, boiler, pliit, 24h vooluühendus, sis. veeühendus ja kanalisatsioon)/ Combined kitchen (sink, hot plate, boiler, refrigerator, water supply, drainage)	210,00
601	Valamu+boiler (sisaldab veeühendust ja kanalisatsiooni)/ Sink+boiler (includes water supply and drainage)	180,00
603	Valamu (külm vesi, sisaldab veeühendust ja kanalisatsiooni) / Sink (cold water, includes water supply and drainage)	140,00
605	Veeühendus (s.h. tarbimine)/ Water supply	65,00
607	Kanalisatsiooniühendus (võimalusel) / Drainage (if possible)	65,00
608	Suruõhuühendus - 7 atm. 250 l/min. / Compressed air - 7 atm. 250 l/min.	60,00

*Suruõhuühendus üle 7 atm. eritellimusena. Hinnapakumise saamiseks palume pöörduda messi projektijuhi poole.

*Compressed air more than 7 atm. is special order. Price-offer please ask from Project Manager.

Hindadele lisatakse käibemaks 20%. VAT 20% will be added to the prices.

Valgustus ja elekter / Lighting and electrics



Kood Code	Nimetus / Item	Hind € Price €
500	Jaotuskilp / Main switch board 220/380V, 16A, 10kW	150,00
501	Jaotuskilp / Main switch board 220/380V, 32A, 20 kW	220,00
Valgustid/Lamps		
510	Kohtvalgusti /Spotlight VIP 75W 230V	47,00
511	Kohtvalgusti lattjuhtmel / Spotlight on wired profile 75W	24,00
512	Kohtvalgusti varrel (50 cm) / Spotlight with holder (50 cm) UFO150W 220V	37,00
513	Kohtvalgusti / Spotlight Crypton 150W 230V	58,00
515	Halogeenvalgusti (lattjuhtmel) / Low voltage light on wired profile 50W 12V	37,00
516	Rippvalgusti metallhaliid (Kuppel) / Metal halide spotlight 400W	78,00
514	Metallhaliidprožektor/Metal halide low voltage light Leo 400W (vajab montaažiks trussingut/needs trussing for installation)	53,00
517	Halogeenprožektor hajuva valgusvooga / Low voltage light, scattered light 300W	47,00
518	Halogeenprožektor hajuva valgusvooga / Low voltage light, scattered light 500W	53,00
519	Prožektor / Ceiling spotlight 1000W	78,00
520	Luminofoorvalgusti (katteta) / Fluorescent light 36W	27,00
Elektriühendused / Electrical connections:		
540	Pistikupesa EU standard kaitsekontaktiga / Plug socket, EU standard 220V 1,0kW 4,5A	27,00
540v	Pistikupesa EU standard kaitsekontaktiga (välipind) / Plug socket, EU standard (outdoor) 220V 1,0kW 4,5A	47,00
542	Pistikupesa EU standard kaitsekontaktiga / Plug socket, EU standard 3,5kW 16A	42,00
542v	Pistikupesa EU standard kaitsekontaktiga (välipind) / Plug socket, EU standard (outdoor) 3,5kW 16A	62,00
545	Pistikupesa külmkapile / Plug socket for refrigerator 220V, 1,0 kW, 24 h	52,00
545v	Pistikupesa külmkapile (välipind) / Plug socket for refrigerator (outdoor) 220V, 1,0 kW, 24 h	68,00
546	Jõupesa EU standard, kaitsekontaktiga / Plug socket, EU standard 380 V, 16 A, 10 kW	100,00
546v	Jõupesa EU standard, kaitsekontaktiga (välipind) / Plug socket, EU standard (outdoor) 380 V, 16 A, 10 kW	115,00
547	Jõupesa EU standard, kaitsekontaktiga / Plug socket, EU standard 380 V, 32 A, 20 kW	170,00
547v	Jõupesa EU standard, kaitsekontaktiga (välipind) / Plug socket, EU standard (outdoor) 380 V, 32 A, 20 kW	225,00
547s	Jõupesa EU standard, kaitsekontaktiga (soojakule) / Plug socket, EU standard (for heated shelter) 380 V, 32 A, 20 kW	105,00

548	Jõupesa EU standard, kaitsekontaktiga (3 päeva) / Plug socket, EU standard (3 days) 380 V, 63 A, 40 kW	325,00
548v	Jõupesa EU standard, kaitsekontaktiga 3 päeva (välipind)/ Plug socket, EU standard 3 days (outdoor) 380 V, 63 A, 40 kW /	365,00
548a	Jõupesa EU standard, kaitsekontaktiga (välipind) iga järgnev päev / Plug socket, EU standard (outdoor) every next day 380 V, 63 A	65,00
560	Pikendusjuhe - kolme pesaga / Outlet cable 220 V (3, 5m)	10,00
Muud teenused/Other services		
825	Elektritööd (tund)/Electrical installation works (hour)	40,00
570	Trussing/ Truss m	18,00
571	Trussingu nurk/Truss corner	20,00

Jäätmekäitlusvahendid / Waste handling appliances



Kood Code	Nimetus / Item	Hind € Price €
377	Prügikast+kilekotid (prügikasti tühendatakse 1x päevas)/ Waste paper basket + waste bags (emptying once a day)	6,00
377a	Prügikasti lisatühjendus 1x /Additional emptying of waste paper basket 1x	2,50
378	Prügikonteiner (konteinerit tühjendatakse 1x päevas) /Waste bag holder (emptying once a day) (100 and 150 l)	17,00
378a	Prügikonteineri lisatühjendus 1x /Additional emptying of waste bag holder 1x	5,00
379	Prügikonteineri kilekotid 10 tk /Waste bags (10 pieces)	7,00
376	Suuremahulise prügi (taara ja ehituspraht) koristamine 1m ³ /Removal of large-scale waste (packages and rubble) 1m ³	15,00

Koristusteenus / Cleaning services

Kood Code	Nimetus / Item	Hind € Price €
827-1	Stend suurusega kuni 10 m ² /Stand up to 10 m ²	18,00
827-2	Stend suurusega 11 - 20 m ² /Stand 11 - 20 m ²	25,00
827-3	Stend suurusega 21 - 30 m ² /Stand 21 - 30 m ²	35,00
827-4	Stend suurusega 31 - 50 m ² /Stand 31 - 50 m ²	55,00
827-5	Stend suurusega 51-100 m ² /Stand 51-100 m ²	60,00
827-6	Stendi suurus üle 100 m ² iga järgnev 50 m ² /Stand larger than 100 m ² , every next 50 m ²	40,00
Stendi igapäevane koristamine messiperioodil - sisaldab: põranda pühkimine ja pesemine või tolmu imemine, mööblilt tolmu pühkimine ja prügikasti tühjendamine./ Stand cleaning during whole fair period: includes floor sweeping and wiping with a damp cloth or vacuum-cleaning, wiping of furniture and emptying of waste basket.		
828	Koristamine 1xpäevas 1m ² /Cleaning once a day (1m ²)	1,00

Hindadele lisatakse käibemaks 20%. VAT 20% will be added to the prices.

AV-teenused ja –tehnika / AV-services and technics



751a/752



749

Kood Code	Nimetus / Item	Hind € Price €
Telerid/TV-s		
751a	32" (81 cm) Televiisor (periood) /Flatt TV (period)	65,00
752	40" (107cm) Televiisor (periood) /Flatt TV (period)	110,00
752a	48" Televiisor (periood) /Flatt TV (period)	155,00
749	55" Televiisor (periood) /Flatt TV (period)	190,00
747	60" Televiisor (periood) /Flatt TV (period)	220,00
746	65" Televiisor (periood) /Flatt TV (period)	270,00
750	75" Televiisor (periood) / Flatt TV (period)	330,00
744	82" Televiisor (periood) / Flatt TV (period)	410,00
745	Põrandajalg 32-64" ekraanile (periood)/ TV 32-64" holder/leg standing (period)	45,00
346	TV seinakinnitus (paar)/ TV wall fastener (pair)	10,00
Projektorid/Projectors		
419	DATA-projektor (päev) / DATA-projector (day)	50,00
Ekraanid ja tahvlid/Screens and whiteboards		
758	1,5*1,5m ekraan statiiviga (päev)/ Screen with holder (day)	18,00
759	2*3 m ekraan (päev) / Screen (day)	15,00
760	1*1,5 m ekraan (päev) / Screen (day)	5,00
Helivõimendus/Sound system		
708	Võimendi+kõlari rent (päev) / Amplifier rent (day)	40,00
711	Raadiomikrofon (1 tk/päev) / Radio microphone rent (day)	35,00
Reklaamikanal eksponentidele/Marketing channel for exhibitors		
705	Reklaami edastamine infokanal (1x) (kuni 30 sek)/ Advertising in info-channel (1x) (max 30 sec)	4,00
Muud teenused/Other services		
700	Helitehnik, videotehnik (tund)/ Audio and video technician (hour)	39,00

Töste- ja riputusteenused / Lifting and hanging services

Kood Code	Nimetus / Item	Hind € Price €
829-1	Töstuk (kuni 3t) koos juhiga - 15 min. /Forklift with driver (max load 3t) - 15 min.	17,00
829-2	Töstuk (kuni 3t) koos juhiga - 1 tund/ Forklift with driver (max load 3t) - one hour	50,00
829-3	Töstuk (kuni 3t) koos juhiga - 4 tundi /Forklift with driver (max load 3t) - four hours	130,00
850	Käsitöstuk ROCLA (30 minutit) / Lift ROCLA - 30 minutes	12,00
870-1	Korvtöstuk - 1/2 tundi / Lift - 1/2 hour	50,00
870-2	Korvtöstuk - 1 tund / Lift - one hour	75,00
870-3	Korvtöstuk - iga järgnev tund (juhul kui kasutatakse üle 1 h)/ Lift - every next hour (when used more than 1 hour)	46,00
Riputuspunktid (1 riputuspunkt ja trosside allalaskmine laest) / Hanging points (1 hanging point for hanging flags, banners and cables from the ceiling)		
NB! Juhul kui halli tehnilised tingimused seda võimaldavad/if halls technical conditions allow		
890-1	Kuni 5 kg (1 riputuspunkt) / Up to 5 kg (1 hanging point)	45,00
890-2	Kuni 50 kg (1 riputuspunkt, vajab montaažiks tali) / Up to 50 kg (1 hanging point, needs a pulley)	75,00
890-3	Kuni 100 kg (1 riputuspunkt, vajab montaažiks tali) / Up to 100 kg (1 hanging point, needs a pulley)	110,00
895	Tali/ Pulley	30,00

18

Muud teenused / Other services

Kood Code	Nimetus / Item	Hind € Price €
830	Laopinna üür (alusele pakitud) min 1 m ³ /period / Storage rental (packed on the pallet) min 1m ³ /period	30,00
824	Näitusestendi ehitustööd (tund)/ Stand construction work (hour)	29,00
825	Elektrik (tund) / Electrical installation works (hour)	40,00
862	Tulekustuti 6l rent (period) / Fire extinguisher 6l rental (period)	35,00

Hüvitised / Amendments

Kood Code	Nimetus / Item	Hind € Price €
880	Eksponeendi viibimine näitusehallis väljaspool lepingus sätestatud kellaaega / Working in exhibition hall beyond the time determined in contract	300,00
820	Rendiinventari puhastamata jätmine m ² / Removal of adhesive tape from wall element m ²	12,00
834	Profiilide puhastamine tk / Removal of adhesive tape from profiles pc	20,00
835	Seinaelemendi 100*250cm rikkumine / Damaging of wall panel 100*250cm	45,00
836	Seinaelemendi 50*250cm rikkumine / Damaging of wall panel 50*250cm	30,00
837	Otsalaua rikkumine jm / Damaging of fascia board m	15,00
838	Püstaku 250cm rikkumine / Damage on 250cm square profile	30,00
839	Pööna 97cm rikkumine / Damage on 97cm beam profile	25,00
816	Põranda rikkumine, sh vaibateibi eemaldamata jätmine m ² / Damage of floor, including during carpet tape removal m ²	2,00

Hindadele lisatakse käibemaks 20%. VAT 20% will be added to the prices.

Graafikateenused / Graphics services

Elavda oma stendi piltidega. Teostame eritellimusena pilte ja bannereid erinevatele materjalidele: kleepkilele, kangale ja erinevatele plaat-materjalidele) (kapa, pvc, acrüül, makrolon, viscom jne.). Banderollid, bännerid ja muud kleepetööd – muudame sinu stendi visuaalselt atraktiivseks!



Kapaplaadile trükitud pildid.
Image prints on light-weight board (kapa).

Print services. We can supply your stand custom made prints on several materials: self-adhesive vinyl, fabrics, plates, light-weight board, acryl etc. Banners, image enlargements, roll up stands, special colour coverings – let's make your stand attractive!



Erinevat värvi kiledega kaetud otsalauad, infoletid, logod ja tekstid.
Special colour coverings on fascias and desks, logos, image prints on the walls and desks.



Kasuta suuri pilte – nendega saab katta terve stendi.
All wall elements covered with prints.



Kleepkilettekstid ja pildid seinaelementidel.
Self-adhesive vinyl prints attached to the wall elements.



Kasuta ka stendi kohal olevat ruumi, et muuta ennast hästi nähtavaks.
Laest saab alla riputada lippe ja bannereid.
Use also the space above your stand. Banners, flags and sign boards can be suspended from the ceiling.



Infolettide paneele on võimalik katta nii, et konstruktsiooni ei ole näha.
Info stand's front panels covered with prints made on pvc board.

Otsalaualogod ja –tekstid / Fascia logos and texts

Ettevõtte logo või tekst on oluline informatsioon messikülastajale. Ära unusta neid tellimast! Logod tuleks saata e-postiga vektorigraafika formaadis ai, eps, cdr.

If you like to have a logo, please send it using vectorized files: Illustrator (ai) or other eps files.

Kood Code	Nimetus / Item	Hind € Price €
801	Kleptäht/Adhesive letter h10 cm HELVETICA medium	1,00
802	Kleptäht/ Adhesive letter h11-15 cm HELVETICA medium	2,00
810	Riigi lipp otsalaual/State flag on the fascia 20*30 cm	4,00
821	Ühevärviline logo/ One-colour logo h30*max 100 cm	19,00
822	Kahevärviline logo/Two-colour logo h30*max 100 cm	25,00
823	Kolmevärviline logo/Three-colour logo h30*max 100 cm	31,00
824	Näitusestendi ehitustööd (tund) / construction works (hour)	25,00
612	Takjateip, selle kinnitamine profiilile ja eemaldamine jm / Zip fix tape, fastening to the profile and removal 1m	1,80
236	Seinaelemendi kiletamine värvilise kilega/Covering wall elements with coloured adhesives 1m ²	15,00

20

Kunsttaimed / Decorative plants



Kood Code	Nimetus / Item	Hind € Price €
611	Dekoratiivpuu /Artificial tree	18,00

Internetiühendus / Internet connections

Traadiga Internetiühendus / Wired Internet connection



Eksponeendil on võimalik tellida oma stendile traadiga Internetiühendus kiirusega kuni 10 Mbit/s kõigis messihallides Citic Telecom CPC Estonia OÜ e-postiaadressil: sales@linxtelecom.ee, telefonil 622 3360 või Interneti-aadressil: www.linxtelecom.ee/mess.

It is possible for the Exhibitor to place an order for a wired Internet connection with a speed of up to 10 Mbit/s in all trade fair halls by the e-mail address of Citic Telecom CPC Estonia LLC: sales@linxtelecom.ee, by phone +372 622 3360 or at the Internet address: www.linxtelecom.ee/mess

WIFI Elisalt / Wifi connection from Elisa

Eesti Näituste messikeskuses pakub tasuta wifi-teenust Elisa Eesti AS.

Elisa is providing WIFI access at the Estonian Fairs Centre.

Logistikateenused / Logistics services

EkspONENT korraldab eksponaatide transpordi konkreetsele näitusele või messile ja tagasi sihtkohta oma kulul ning vastutab kõigi oma eksponaatidega seonduvate tolliformaalsuste täitmise eest. Tolli- ja transporditeenuseid on võimalik tellida: UPEX LS OÜ – Pirita tee 28, 10127 Tallinn; tel 6137433; faks 6112851, GSM 511 9947, e-post: upex@upex.ee, www.upex.ee.

The Exhibitor shall organise the transport of the Exhibits to the particular exhibition or trade fair and back to the place of destination at his/her own expense and be responsible for the completion of customs formalities connected to all his/her Exhibits. Orders on customs and transport services can be placed:

UPEX LS Ltd – Pirita Street 28, 10127 Tallinn, Estonia; phone +372 6137433; fax +372 6112851, GSM +372 511 9947, e-mail: upex@upex.ee, www.upex.ee.

21

Toitlustusteenused / Catering services

Messi eksponentide ja teenindava personali toitlustamise eest hoolitsevad Näituste Baari OÜ ja Amps Catering.

Fuajee ülakorrusel töötab messiperioodil Amps Catering restoran-bistroo mahutavusega kuni 140 kohta ning B-hallis töötab Näituste Baari kohvik-baar mahutavusega kuni 50 kohta.

Messi ajal on võimalik tellida toitlustusteenust ka stendile. Lisainformatsioon:

Amps Catering: tiia@amps.ee, Tiia Irdoja

Näituste Baari OÜ: +372 501 5095, Liivia Eensalu

Exhibitors and service personal catering is done by Näituste Baari Ltd and Amps Catering.

Upper floor of lobby is working restaurant-bistro capacity max 140 places by Amps Catering and in B-hall is working coffee-bar capacity max 50 places by Näituste Baari.

There is possibility to order catering services to the stand.

Additional information:

Amps Catering: tiia@amps.ee, Tiia Irdoja

Näituste Baari OÜ: +372 501 5095, Liivia Eensalu



Konverentsiteenused / Conference services

Meie konverentsiruumides on võimalik korraldada nõupidamisi, seminare ja erinevaid kliendiüritusi.

A-paviljoni I korruse konverentsisaal:

- 180 kohta teatristiilis (max 50 lisatooli paigutamise võimalus);
- DATA-projektor
- magnettahtvel
- pabertahvel

A-paviljoni II korruse konverentsiruum:

- 120 kohta teatristiilis või 60 kohta seminaristiilis või 40 kohta ümarlauastiilis;
- DATA-projektor
- pabertahvel

B-paviljoni II korruse seminariruum:

- 30 kohta teatristiilis või 20 kohta seminaristiilis või 14 kohta ümarlauastiilis;
- DATA-projektor;
- pabertahvel



In our conference premises is possible to hold meetings, seminars and customer events.

The conference room on the ground floor of Exhibition Hall A:

- 180 places in theatre-style (a possibility of max. 50 additional chairs);
- data projector
- magnetic display board
- flipchart

The conference room on the first floor of Exhibition Hall A:

- 120 places in theatre-style or 60 places in workshop-style or 40 places in round-table-style;
- data projector
- flipchart

The workshop room on the first floor of Exhibition Hall B:

- 30 places in theatre-style or 20 places in workshop-style or 14 places in round-table-style;
- data projector;
- flipchart

Kontserdi-, peo- ja esitlusteenused

Eesti Näituste messikeskuse paviljonid on sobivad suure vaatajate-kuulajate arvuga kontsertide korraldamiseks. Messikeskuses on esinenud sellised maailmanimega staarid ja ansamblid nagu Brian Adams, Joe Cocker, Savage Garden, Jethro Tull, Kraftwerk, Gotan Project, Kimmo Pohjonen, Dieter Bohlen koos ansambliga Blue System jt.

Eesti Näituste AS osutab kontserdikorraldajaile alljärgnevat teenuseid:

- ruumide üürimine;
- esinejate puhke- ja management'i tööruumide ehitamine ja sisustamine;
- telefoni- ja internetiühendus puhke- ja tööruumidesse;
- tõste- ja transporditeenused;
- riidehoiu- ja koristusteenus;
- turvateenus;
- parklateenus.

Messikeskuse paviljonid on sobivad nii suur- kui väike- ja keskmise suurusega firmade pidude, kliendivastuvõtude jms korraldamiseks.



Eesti Näituste AS osutab peokorraldajatele alljärgnevaid teenuseid:

- projektijuhtimisteenused;
- ruumide üürimine ja kujundamine;
- dekooriteenused;
- tantsupõranda ehitamine;
- laudade-toolide üürimine;
- lavaehitus;
- tõste- ja transporditeenused;
- esinejate riietus- ja puhkeruumide ehitamine ja sisustamine;
- riidehoiu- ja koristusteenus;
- turvateenus;
- parklateenus;
- koostööpartnerite abil;
- toitlustusteenus;
- heli- ja valgustusteenused;
- meelelahutusprogrammi koostamine ja korraldamine;
- lilleseadeteenused.



Eesti Näituste messikeskuse paviljonid ja avaväljakud on sobivad kliendipäevade, toote- ja teenusesitluste, näituste jm ürituste korraldamiseks, mille raames lisanduvad Eesti Näituste AS-i poolt ürituse korraldajale osutatavatele eelnimetatud teenustele veel:

- näituse- ja esitlusinventari üürimine;
- stendiehitusteenused;
- konverentsiteenused;
- kleebisreklaamiteenused.

Peo, esitluse, vastuvõtu ja näituse korraldamine messikeskuses võimaldab realiseerida Teie julgemagi fantaasia, luua just Teie ürituseks sobiva ruumiprogrammi, interjööri ja meeleolu ning muuta iga üritus kordumatuks ning meeldejääviks sündmuseks.

Renditingimused / Rental terms

Konstruksioonide ja mööbli rendi hind sisaldab renti kogu perioodi jooksul ning nende montaaži ja demontaaži. Juhul, kui juba standile toodud elemendi tellimus annulleeritakse siis on Eesti Näituste AS-l õigus kohaldada selle rendihinda täies mahus. Renditavad konstruktsioonid ja mööbel on kasutamiseks vaid sisetingimustes. Seinaelementidele ja mööblile reklaamide ja bännerite kinnitamiseks võib kasutada vaid kergelt eemaldatavaid teipe ja riputuskonkse. Teibid tuleb pärast messi lõppu eemaldada. Juhul kui seinaelemendid, mööbel või muu inventar rikutakse on Eesti Näituste AS-l õigus nõuda nende hüvitamist.

The price for construction and furnishings covers the rental and installation and dismantling costs for the whole exhibition. In case an ordered product delivered to the stand is cancelled, Estonian Fairs Ltd reserves the right to charge full price. Constructions and furnishings available for rent are intended for interior use only. Objects may be fixed to wall elements and furniture only with light adhesives and decoration hooks. The adhesives must be removed by the exhibitor. If wall elements, furniture or other items is damaged Estonian Fairs Ltd reserves the right to charge the exhibitor the cost of damaged items

24

Maksetingimused / Terms of payment

Hindadele lisatakse kehtiv käibemaks. Maksetingimus on 10 päeva, juhul kui teisiti ei märgita. Messi eksponeerimispäeval tehtud tellimustele kehtib hinnalisa 50%. Reklamatsioonid ja pretensioonid tuleb esitada messi ajal teenindusbüroosse.

Applicable VAT will be added to prices. Terms 10 days net, unless otherwise indicated. Orders made during exhibition layout days will be subject to a 50% surcharge. Complaints shall be issued during the exhibition to the Exhibitor Service.

Stendi joonis

Stand sketch

25

Firma/Company	Mess/Fair
Kontaktisik/Contact person	Stendi number/Stand number
E-mail	Telefon/Phone

1m	1m													Kood/Code	Kogus/Qnt.	

Kõikidele kujundus- ja konstruktsioonelementidele palume joonisel lisada koodid
Please mark codes of furniture and constructions to the sketch

- | | | | | | | | |
|--|------------------------------|--|------------------------------|--|--------------------------------------|--|------------------------------|
| | Seinaelement
Wall element | | Laud
Table | | Akrüülsein
Wall panel acrylic | | Külmutuskapp
Refrigerator |
| | Otsalaud
Fascia board | | Infolett
Info/bar counter | | Peegel
Mirror | | Pistikupes
Plug socket |
| | Tahveluks
Hinged door | | Tool
Chair | | Riiul Lundia
4 shelf storage unit | | Kohtvalgusti
Lamp |
| | Lükanduks
Folding door | | Seinariiu
Shelf | | Vitriin
Showcase | | Baaritool
Bar chair |
| | Kardin
Curtain | | Seinanagi
Cloth rack | | Kraanikauss
Sink | | |

Tekst otsalaul/Text on the fascia

--	--	--	--	--	--	--	--	--	--	--	--	--	--	--	--	--	--	--	--	--	--	--	--	--	--	--	--	--	--	--	--	--	--	--	--

Allkiri/Signature

Kuupäev/Date

Eesti Näituste messikeskus / Estonian Fairs Centre

Tehniline informatsioon / Technical information

A-hall I korrus

* Pindala 665 m²

* Kõrgused:

laeni 3,0m
barjääri ülaosani 5,01m
keskosas laeni 6,8m

* Põranda maksimaalne kandevõime 2000 kg/m²

* Tarbitava elektrivõimsuse piirmäär: 165 P max/kW; 750 (3*250) J max/A

* Kaubavärvad:

A1: kõrgus 2,3m, laius 3,8m

A-hall II korrus

* Pindala 837 + 203m² (konverentsisaal)

* Kõrgused:

talani 2,8m
laeni 3,7m
barjääri kõrgus 0,97m

* Põranda maksimaalne kandevõime 400 kg/m²

* Tarbitava elektrivõimsuse piirmäär: 165 P max/kW; 750 (3*250) J max/A

* Kaubavärvad:

A2: kõrgus 2,55m, laius 3,55m

B-hall I korrus

* Pindala 996m²

* Kõrgused:

talani 3,5m
barjääri ääreni 4,99m
keskosast talani 6,8m

* Põranda maksimaalne kandevõime 4000kg/m²

* Tarbitava elektrivõimsuse piirmäär: 257 P max/kW; 1170 (3*390) J max/A

* Hallis on veevõtu ja kanalisatsiooniühendused

* Kaubavärvad:

B1: kõrgus 3,1m, laius 4,2m

B-hall II korrus

* Pindala 940 m²

* Kõrgused:

talani 2,8m
laeni talade vahelt 3,9m
barjääri kõrgus 0,95m

* Põranda maksimaalne kandevõime 300 kg/m²

* Tarbitava elektrivõimsuse piirmäär: 257 P max/kW; 1170 (3*390) J max/A

* A ja B halli vaheliste uste mõõdud: kõrgus 1,8m; laius 1,5m

C-hall

* Pindala 4800 m²

* Kõrgused:

fermideni 8,0m
maksimaalne ehituskõrgus 7,5m
fermide vahe 10,0m

* Põranda maksimaalne kandevõime 4000 kg/m²

* Tarbitava elektrivõimsuse piirmäär: 389 P max/kW; 1770 (3*590) J max/A

* Hallis on veevõtu ja kanalisatsiooniühendused

* Kaubavärvad:

C1: kõrgus 4,04m, laius 4,8m

C2: kõrgus 4,04m, laius 5,8m

C3: kõrgus 3,5m, laius 2,8m

C4: kõrgus 4,04m, laius 4,8m

C5: kõrgus 4,78m, laius 4,48m

Fuajee ja C-halli vaheline uks: kõrgus 2,4m, laius 4,8m

D-halli ja C-halli vaheline uks: kõrgus 3,5m, laius 8,4m

D-hall

NB! Ekspositsioonipinnana kasutatav üksnes kaitsepõranda paigaldamisel.

Eksponeerimisvõimalused ja -tingimused kooskõlastatakse eelnevalt Eesti

Näituste ASiga.

* Pindala 1995m²

* Kõrgused:

keskosas 7,2m(valgustiteni), fermideni 8,7m
seinast 1,5m kaugusel 5,4m

* Tarbitava elektrivõimsuse piirmäär: 389 P max/kW; 1770 (3*590) J max/A

* Kaubavärvad:

D1: (kalle/tõus 7cm): kõrgus 3,3m, laius 2,7m

D2: kõrgus 4,9m, laius 3,8m

D3: (kalle/tõus 7cm): kõrgus 3,3m, laius 2,7m

A-hall I floor

* Surface 665 m²

* Height:

up to the ceiling 3,0m
up to the upper block of the barrier 5,01m
up to the ceiling in the middle of the hall 6,8m

* Maximum loading capacity of floor 2000 kg/m²

* Maximum limit of electric output: 165 P max/kW; 750 (3*250) J max/A

* Service door:

A1: height 2,3m, width 3,8m

A-hall II floor

* Surface 837 + 203m² (conference hall)

* Height:

up to the beam 2,8m
up to the ceiling 3,7m
height of the barrier 0,97m

* Maximum loading capacity of floor 400 kg/m²

* Maximum limit of electric output: 165 P max/kW; 750 (3*250) J max/A

* Service door:

A2: height 2,55m, width 3,55m

B-hall I floor

* Surface 996m²

* Height:

up to the beam 3,5m
up to the upper block of the barrier 4,99m
up to the beam in the middle of the hall 6,8m

* Maximum loading capacity of floor 4000kg/m²

* Maximum limit of electric output: 257 P max/kW; 1170 (3*390) J max/A

* Connections to plumbing and drainage are available

* Service door:

B1: height 3,1m, width 4,2m

B-hall II floor

* Surface 940 m²

* Height:

up to the beam 2,8m
up to the ceiling between beams 3,9m
barrier height 0,95m

* Maximum loading capacity of floor 300 kg/m²

* Maximum limit of electric output: 257 P max/kW; 1170 (3*390) J max/A

* Doors between halls A and B hall: height 1,8m; width 1,5m

C-hall

* Surface 4800 m²

* Height:

up to the beams 8,0m
Maximum building height 7,5m
space between beams 10,0m

* Maximum loading capacity of floor 4000 kg/m²

* Maximum limit of electric output: 389 P max/kW; 1770 (3*590) J max/A

* Connections to plumbing and drainage are available

* Service doors:

C1: height 4,04m, width 4,8m

C2: height 4,04m, width 5,8m

C3: height 3,5m, width 2,8m

C4: height 4,04m, width 4,8m

C5: height 4,78m, width 4,48m

Door between lobby and hall C: height 2,4m, width 4,8m

Door between halls D and C: height 3,5m, width 8,4m

D-hall

NB! Exhibiting possibilities and conditions will be settled additionally with Estonian

Fairs Ltd

* Surface 1995m²

* Height:

In the middle of the hall 7,2m(up to lamps), up to beams 8,7m
from the wall 1,5m height 5,4m

* Maximum limit of electric output: 389 P max/kW; 1770 (3*590) J max/A

* Service doors:

D1: (slope/rise 7cm): height 3,3m, width 2,7m

D2: height 4,9m, width 3,8m

D3: (slope/rise 7cm): height 3,3m, width 2,7m

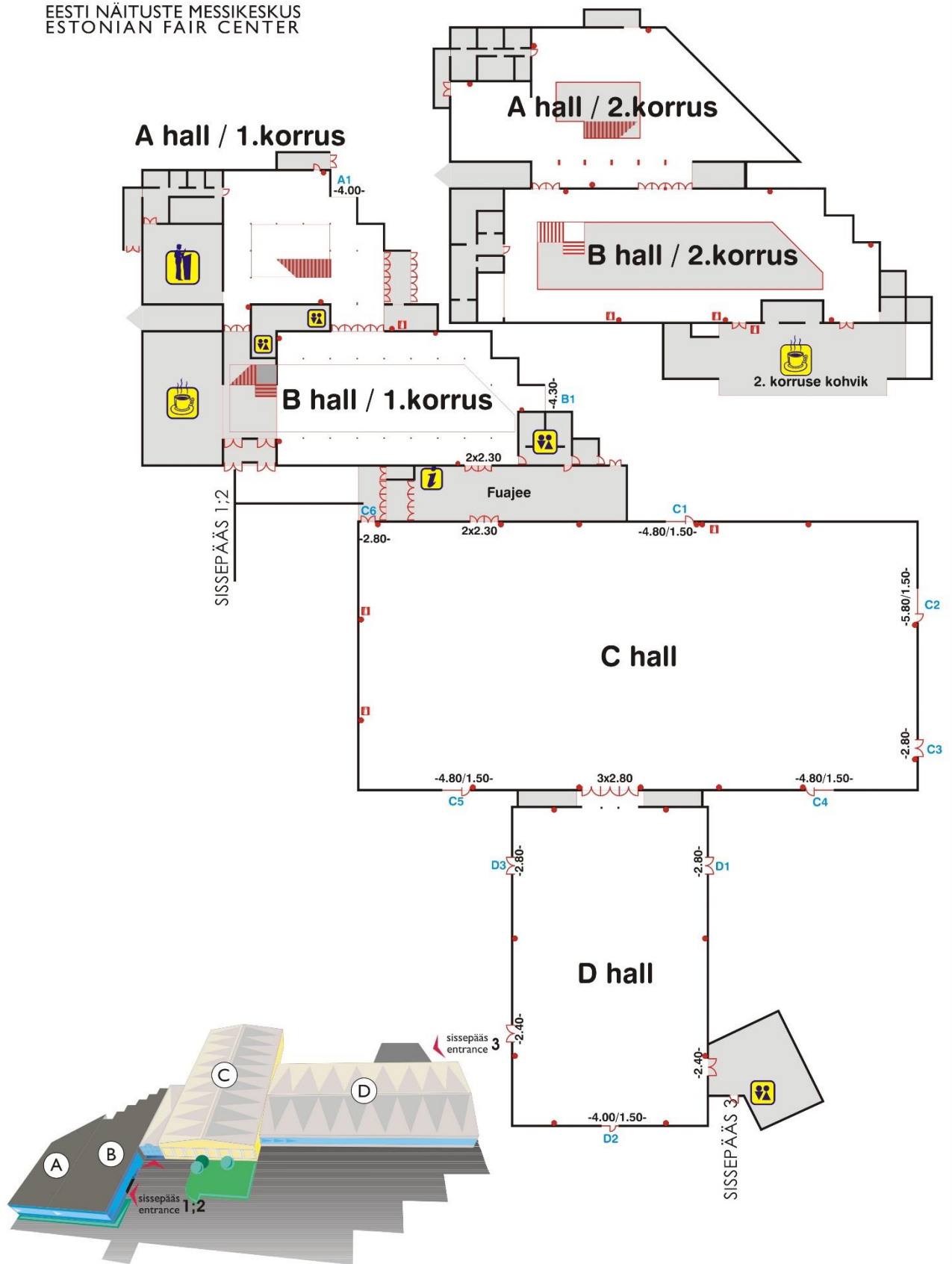

Messikeskuse asukoht ja üldkontaktid

How do get there and general contacts



Eesti Näituste messikeskus asub vaid 10 minuti kaugusel kesklinnast ja siia saab mugavalt bussidega number 1A, 5, 8, 34A ja 38 - Lauluväljaku peatus.

Estonian Fairs Center locates only 10 minutes from city centre. You can drive easily to us by busses no 1A, 5, 8, 34A and 38 - bus stop "Lauluväljak".

Eesti Näituste AS
Pirita tee 28, 10127 Tallinn
Reg. nr. 10017313
MKMR.: EE100295692
Telefon 6137337, faks 6137447
e-post: fair@fair.ee

Estonian Fairs Ltd
28 Pirita Road, 10127 Tallinn, Estonia
Reg. no. 10017313
VAT id No: EE100295692
Tel. +372 6137337, fax +372 6137447
e-mail: fair@fair.ee

www.fair.ee

EkspONENTI MEMO / EXHIBITORS MEMO

<p>Kutsed klientidele ja koostööpartneritele</p> <p>Ehitajapassid</p> <p>EkspONENTI PASSID</p> <p>Montaaži ja demontaaži graafikud</p> <p>Parklakaardid</p> <p>Messikataloogi informatsioon korraldajale</p> <p>Teadanded uutest toodetest korraldajale</p> <p>Pressiteated</p> <p>Töötajate informeerimine</p> <p>Juhtkonna informeerimine</p> <p>Reklaam</p> <p>Lähetused ja hotellid</p> <p>Stendil töötava meeskonna ettevalmistus</p> <p>Reklaamvoldikud, meened, stendimeeskonna rõivastus jms</p> <p>Koosoleku- ja nõupidamisruumide rent</p> <p>Stendi toitlustus</p> <p>Stendi kujundus</p> <p>Stendi ehitamise ja turvalisuse juhendid</p> <p>Stendijoonise kinnitamine korraldaja poolt</p> <p>Konstruksioonid</p> <p>Mööbel</p> <p>Vaipkate</p> <p>Valgustus ja elekter</p> <p>AV-tehnika</p> <p>Tekstid, logod, pildid ja muu graafiline teostus</p> <p>(Kunst)lilled</p> <p>Vesi, kanalisatsioon ja suruõhk</p> <p>Koristus</p> <p>Turvateenus</p> <p>Jäätmekäitlus</p> <p>Transport, laadimised jms kaubakäsitlus</p> <p>Kindlustused</p> <p>Müügiluba</p> <p>Kliendiinfo kogumine</p> <p>Tagasiside messikorraldajale ürituse ajal</p> <p>Stendi demontaaž ja logistika</p> <p>Järgnevad tegevused</p> <p>Küsimustiku tagastamine korraldajale</p>	<p>Invitations to customers</p> <p>Construction and dismantling passes</p> <p>Exhibitor's passes schedules</p> <p>Construction and dismantling graphics</p> <p>Parking cards</p> <p>Catalogue information to organiser</p> <p>Product news information to organiser</p> <p>Press releases</p> <p>Releases to personnel</p> <p>Releases to principals</p> <p>Advertising</p> <p>Travel and accommodation reservations</p> <p>Training of personnel</p> <p>Brochures, gifts, uniforms etc.</p> <p>Renting of conference facilities</p> <p>Catering services</p> <p>Designing stand</p> <p>Guidelines for stand construction and safety</p> <p>Approval for stand design from the organiser</p> <p>Constructions</p> <p>Furnishing</p> <p>Carpet</p> <p>Lighting and electrics</p> <p>AV-equipment</p> <p>Texts, logos, prints, other graphics</p> <p>Plants</p> <p>Water, drainage and compressed air</p> <p>Cleaning</p> <p>Security services</p> <p>Dump service</p> <p>Transportation, lifting and forwarding</p> <p>Insurances</p> <p>Retail sale permit</p> <p>Collecting customer register</p> <p>Response to the organiser during the exhibition</p> <p>Dismantling and forwarding</p> <p>Follow-up actions</p> <p>Questionnaire to the organiser after the exhibition</p>
--	---